



A+SERIES™ AIR COOLERS



Colmac Coil Manufacturing, Inc.

“The Heat Transfer Experts”

History

Founded in 1971, Colmac Coil Manufacturing initially supplied heating and cooling coils to OEM customers and the HVAC industry. By the early 1980's Colmac Coil had expanded their refrigeration product line to include industrial air coolers and condensers for the ammonia refrigeration industry, developing a reputation for high quality products and the ability to engineer a wide range of heating and cooling solutions using their in-house developed heat and mass transfer modeling software.

As the company continued to grow it was apparent that access to eastern US and Canadian markets would require another manufacturing facility located closer to those customers. In 2009 the company began operations in its second manufacturing facility located in Paxton, Illinois. With two world class manufacturing facilities, Colmac Coil is able to ship products to North and South America markets quickly and cost effectively.



Mission

“The mission of Colmac Coil is to provide heat transfer markets worldwide with innovative, cost effective products that are configured, manufactured, and shipped with the shortest lead times in the industry, with fast, friendly service, for the mutual benefit of our employees, customers, and shareholders.”

Our corporate philosophy is based on an uncompromising commitment to quality, customer service excellence, revolutionary product design, innovative selection software, competitive pricing and on-time shipments. Customers can depend on Colmac Coil engineering expertise to develop the proper design that insures proper performance for each unique application.



Markets

We serve a wide variety of markets and customers with an emphasis in the following industries:

- Industrial Refrigeration
- HVAC
- Power Generation
- Gas Compression

With our ability to accurately predict the performance of our heat exchangers and build with a wide variety of materials, we welcome the opportunity to help you find creative and efficient heat transfer solutions for your process or products.

Our Products

- ▷ **Refrigeration Evaporators**
A+Series™ air coolers, blast freezers/chillers, hydrocoolers, product coolers, and process room coolers
- ▷ **Dry Coolers & Condensers**
For refrigeration, power generation, HVAC, and gas compression industries
- ▷ **Heating & Cooling Coils**
Any air heating or cooling application for almost any temperature and working fluid
- ▷ **Heat Pipes**
Designed to efficiently transfer heat from a warm air stream to a colder one



A+Series™ Air Coolers



A+L High profile

CAPACITY 5 - 100 TR

FEATURES

- Hinged fan panels standard
- “Plug-in” fan section for horizontal, 45° down, or penthouse air discharge



A+M Medium profile

CAPACITY 2 - 50 TR

FEATURES

- Hinged fan panels standard
- Full coverage drainpan design



A+S Low profile

CAPACITY 2 - 35 TR

FEATURES

- Hinged fan panels standard
- Full coverage drainpan design



A+P Penthouse

CAPACITY 10 - 75 TR

FEATURES

- Roof-mounted with 1 to 6 fans



A+R Process Rooms

CAPACITY 3 - 25 TR

- FEATURES**
- “Above Rail” style for use where cleanability is critical
 - Optional CIP piping available
 - Full coverage insulated drainpan



A+D Low Profile Dual Discharge

CAPACITY 2 - 40 TR

- FEATURES**
- Low velocity airflow for highly perishable products
 - Ideal for work rooms with low ceilings
 - Low noise fans standard

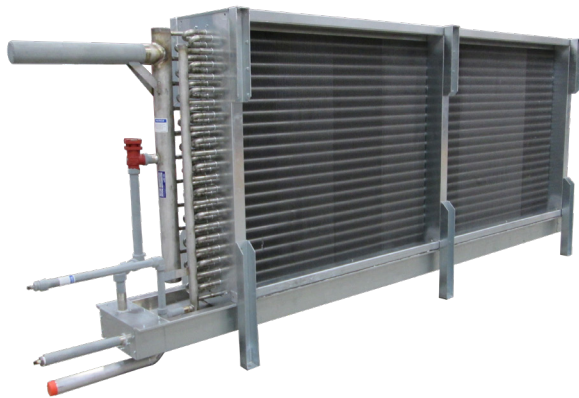

A+B Coil Block with Drainpan

CAPACITY 5 - 100 TR

- FEATURES**
- Custom sizes
 - For use with mini-penthouse units, blast freezers, and critical process air handlers



A+E Low Profile for Commercial Applications

CAPACITY 1.5 - 15 TR

- FEATURES**
- Integral DTFD
 - Optional powder coated cabinet
 - Complete range of working fluids and system types
 - Standard hot gas defrost

A+Series™ Features & Options

Colmac A+Series air coolers offer the most advanced and innovative features in the industry for your industrial refrigeration applications and are designs to provide you with unsurpassed levels of:

Food Safety

Worker Safety

Energy Efficiency

Reliability



Optional Features

- ▷ ADX® Low Charge Ammonia
- ▷ High Performance Glycol
- ▷ Return Air Defrost Hoods
- ▷ Reversing Airflow Fans
- ▷ Anti-microbial Construction
- ▷ Epoxy Coated Fins
- ▷ EC Fan Motors



Optimized Heat Transfer

Three unique tube patterns are used to optimize cooling performance, fan power, and defrost frequency depending on the capacity requirements, working fluid used, and operating temperatures specific to your application. Other manufacturers use a single tube and fin pattern for their product lines, forcing you to accept 'one-size-fits-all' and a less than optimum solution. Not with Colmac Coil!

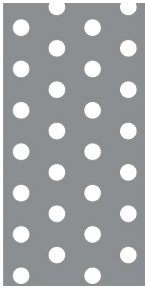

"I" Pattern

5/8" diameter staggered tubes

- ▷ Enhanced plate fins
- ▷ Compact pattern for highest heat transfer efficiency in high heat flux applications
- ▷ Best for high temperature wet fin applications with large TD

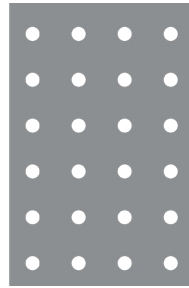

"T" Pattern

5/8" diameter inline tubes

- ▷ Enhanced plate fin
- ▷ Lowest fan power
- ▷ Large secondary (fin) surface area for maximum frost carrying capacity and extended runtime between defrosts
- ▷ Best for low temp frosted fin applications

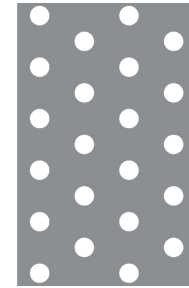

"M" Pattern

7/8" diameter staggered tubes

- ▷ Enhanced plate fin
- ▷ Low fan power
- ▷ Large secondary (fin) surface area for maximum frost carrying capacity and extended runtime between defrosts
- ▷ Best for gravity flooded ammonia and large capacity pumped ammonia



Construction Options

A wide range of cabinet construction options are available to enhance corrosion resistance (stainless steel) and food safety (CIP). A+Series™ coil construction options give you the flexibility to match any working fluid or environment.

Tube Options

- Copper
- Aluminum
- 304SS or 316SS
- Galvanized Steel

Fin Options

- Alum or Epoxy Coated Alum
- 304SS or 316SS
- Anti-microbial - CuNi
- Galvanized Steel

Air Discharge Arrangements

On applicable models, air discharge alternatives include:

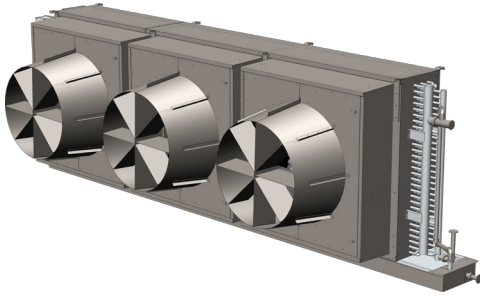

Long throw adapters extend air throw

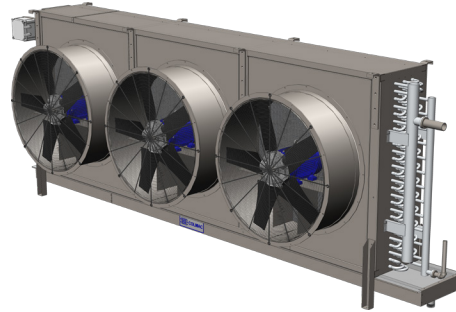

Tube axial fans for added external static pressure (ESP) capability

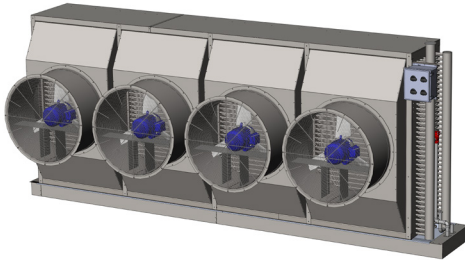

Reversing Airflow

- ▷ Reduces blast freezing or chilling time by as much as 20%
- ▷ Improves product quality
- ▷ Cost effective

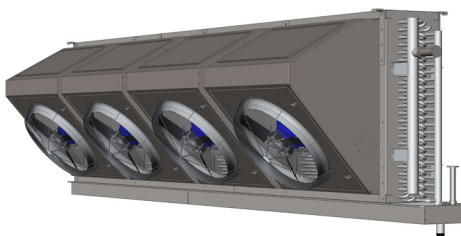

A+L 45° down discharge

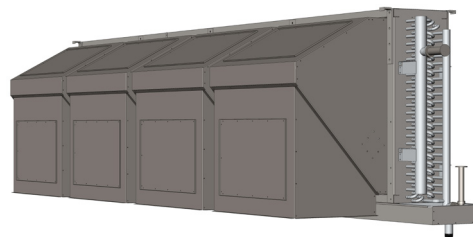

A+L 90° down discharge (penthouse adapters)

A+ L coolers with 45° and 90° penthouse options feature heavy-duty discharge housings that tilt the fans 45° down from the vertical plane. These housings ship installed for ease of installation. Access panels are provided on penthouse adapters to permit service access. Optional discharge duct extensions available.

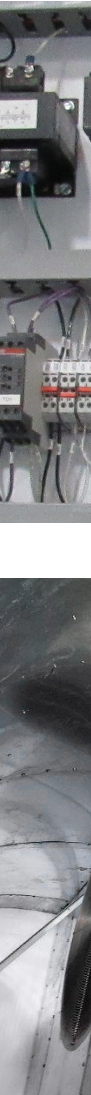

Available For Any Working Fluid

Colmac A+Series™ evaporators can be supplied to utilize any working fluid, either volatile or nonvolatile, primary or secondary. Circuiting is matched to each application and optimized for highest heat transfer with lowest tubeside pressure drop.

Volatile Liquids

- ▷ Ammonia
- ▷ CO2
- ▷ HFCs
- ▷ Liquid Nitrogen

Non-Volatile Liquids

- ▷ Glycols
- ▷ Calcium or Potassium Chloride
- ▷ Dynalene
- ▷ d-Limonene
- ▷ Potassium Formate

Circuiting Options

- ▷ Pumped or CPR bottom feed
- ▷ Pumped or CPR top feed
- ▷ Gravity flooded
- ▷ Direct expansion
- ▷ ADX® Low Charge Ammonia

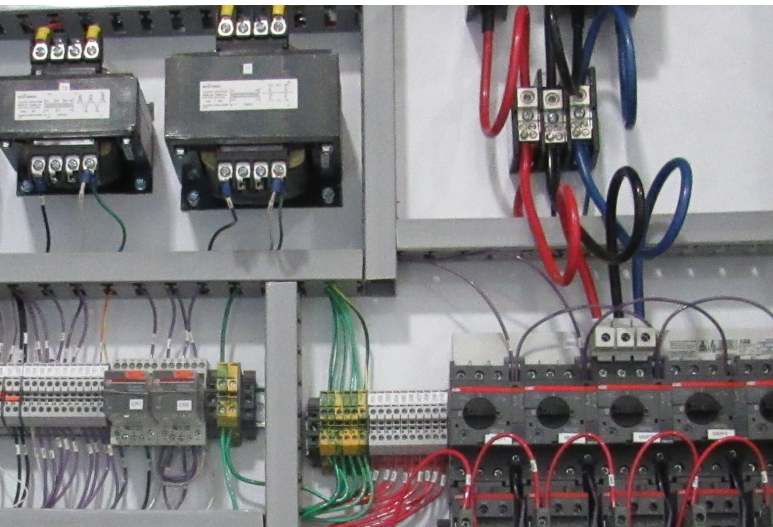

Factory Electrical Wiring Options

- ▷ All motors wired to a common fused or nonfused disconnect switch located in a NEMA 4X box
- ▷ Each motor wired to an individual fused or nonfused disconnect switch located in a NEMA 4X box
- ▷ All motors wired to a control panel with a common fused disconnect switch and individual IEC motor starters. All located in a NEMA 4X box.
- ▷ Customized UL508 listed control panels available for all units



Quality Construction

Coils in our A+Series™ air coolers may be UL listed under standard UL 207 and/or manufactured per the requirements of ASME B31.5.



G235 Galvanized Sheet Metal

- ▷ All galvanized Colmac Coil housings are coated to G235 specifications. This heavier coating means it will be more durable and can be expected to perform 2.6x longer than a more typical G90 coating.

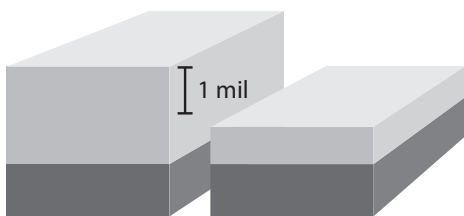

G235 Coating
2.12 mils/side

G90 Coating
.81 mils/side

Epoxy Coated Fins

- ▷ 300% more corrosion resistant than aluminum
- ▷ Flexible - will not chip or peel
- ▷ Cost effective

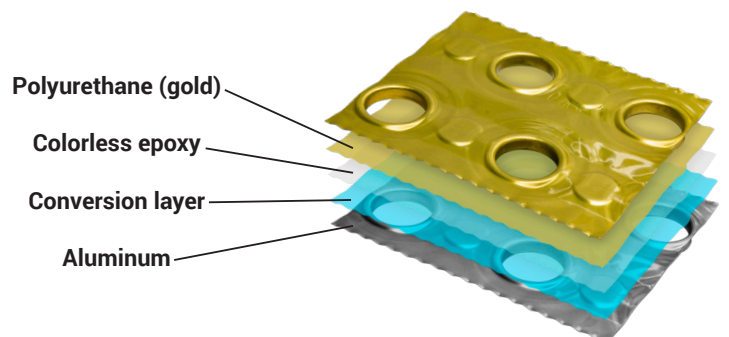

Materials of Construction

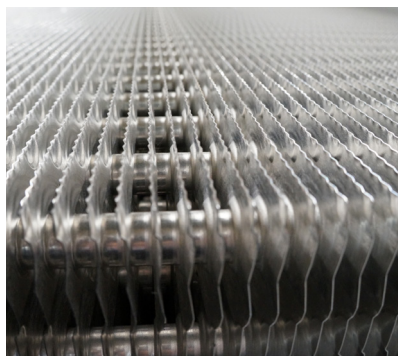

Aluminum Tubes & Fins

Colmac Coil has specialized in all aluminum construction for ammonia air coolers for over 30 years. All aluminum construction offers:

- ▷ Lightest weight
- ▷ Best performance
- ▷ Lowest cost
- ▷ Fastest defrost
- ▷ Good corrosion resistance
- ▷ Patented Bi-Metallic Couplers eliminate flange union connections

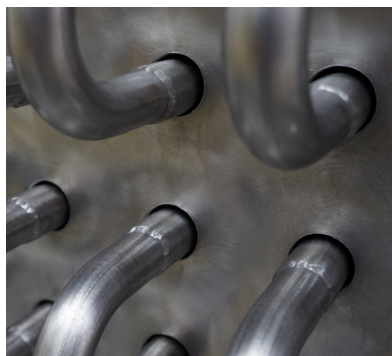

Stainless Steel Tubes

The stainless steel tubes used in this type of construction offer some added corrosion resistance and resistance to mechanical damage compared to all aluminum construction.

A variety of different fin materials are available with stainless steel tubes on A+Series™ air coolers:

- ▷ Aluminum fins
- ▷ Epoxy coated aluminum fins
- ▷ 304 or 316 stainless steel fins
- ▷ Anti-microbial fins

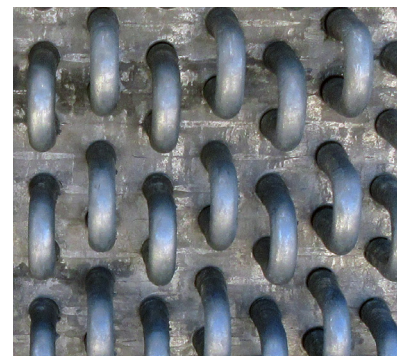

Galvanized Steel Fins & Tubes

In certain cases where highly alkaline cleaners are used directly on coil surfaces, galvanized steel construction may be desirable. This type of construction is significantly heavier (2 or 3 times), has significantly lower performance (12 to 15% less), and is costlier when compared to all aluminum or stainless/aluminum construction.

More detailed information on coil construction can be found in the Technical Bulletin

“Comparing Ammonia Evaporator Construction: Which One is Best?”.

Go to www.colmaccoil.com to download a free copy of this bulletin.

Energy Efficient Airflow

Colmac A+Series™ evaporators use high efficiency fan blades having a true airfoil shape profile for all fan diameters greater than 24 inches. This type of fan offers several advantages over stamped steel or aluminum blades:

High Efficiency

Low Noise

Non-overloading

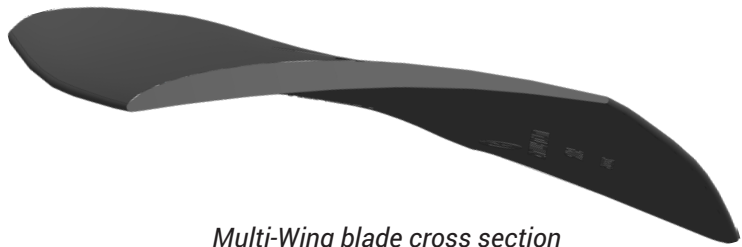

Multi-Wing blade cross section

**36" Diameter Prop Fans @ 1140 RPM
Total Efficiency vs. Static Press**

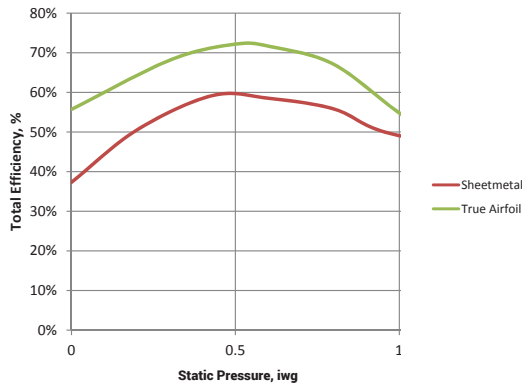

**36" Diameter Prop Fans @ 1140 RPM
Power vs. Static Press**

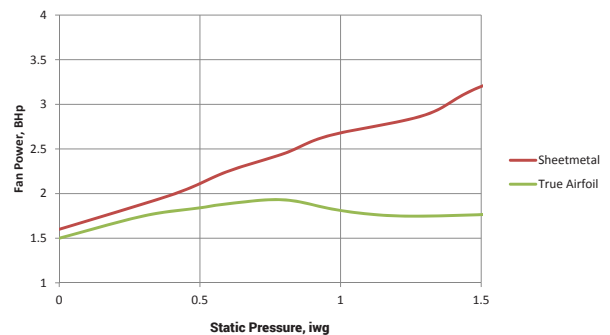

The true airfoil blade shape can achieve mechanical efficiencies of 70%+. The best a stamped steel or aluminum sheetmetal blade can achieve is approximately 60%. This means Colmac A+Series™ evaporators will operate with 10% less fan power for the same cooling load, which not only translates to lower operating costs, but also lower first cost for power cabling and transforming.

The higher efficiency of A+Series™ fans also results in lower sound levels during operation. A wide range of fan diameters and speeds are available to allow the selection of the appropriate sound level for the application and customer requirements.

Another benefit of A+Series™ fans with airfoil shape profile is the non-overloading power vs pressure characteristic curve. The power vs pressure curve is very flat which means that as frost accumulates on the evaporator and static pressure through the coil block increases, the brake power load imposed on the fan motor remains constant. Stamped steel and aluminum sheetmetal fan blades have a steeper power vs pressure curve which results in brake power (and amperage) continuing to rise as frost accumulates and static pressure increases.

C-Face Motors

A+S and A+R air coolers utilize robust C-face motors for reliability, low noise, and ease of replacement. These fractional horsepower motors are designed for 80% minimum efficiency as standard and can be supplied for washdown duty as an option.

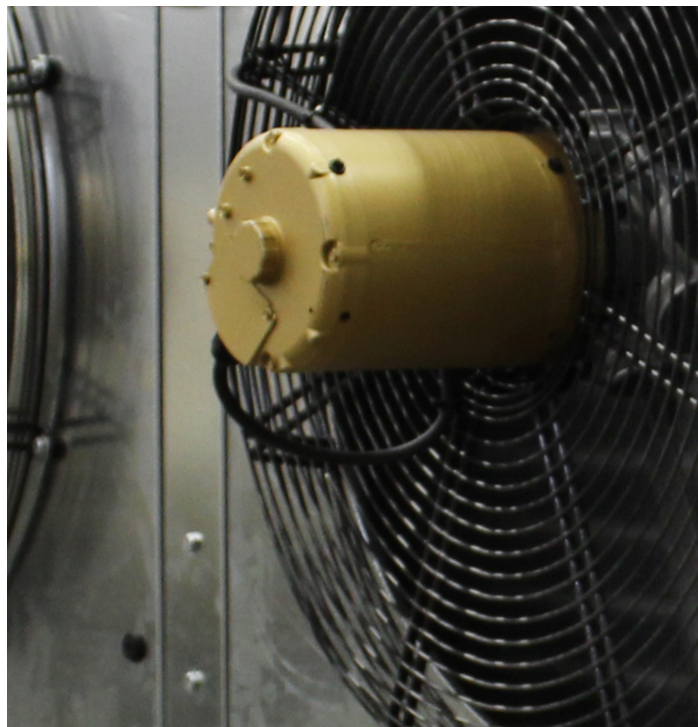
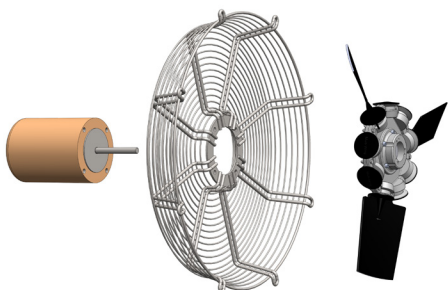

Motor Efficiency

Standard fan and motor combinations on A+Series™ evaporators are optimized for maximum total efficiency. This is different from the integral external rotor fan motor units supplied by other manufacturers. While certain airflow and pressure conditions may result in total efficiencies approaching the A+Series™ efficiency, in many cases the total efficiency for integral external rotor fan motor units is inferior.

Standard A+Series motors are high efficiency, internal rotor, totally enclosed, and VFD compatible. Integral horsepower motors (greater than 1hp) are supplied standard as NEMA Premium Efficiency. Fractional horsepower motors (1hp and less) are supplied standard as 80% minimum efficiency.

Both 1140 rpm (6 pole) motors for high capacity applications and 850 rpm (8 pole) motors for low noise applications are available. Motors are suitable for either 50 or 60 Hz supply voltage.

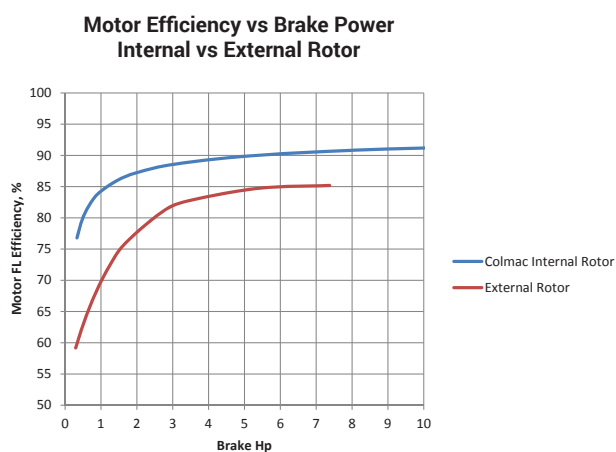

ADX[®] Low Charge Ammonia

An inherently safer technology for low charge ammonia evaporators offering:

- **Lower first cost**
- **Lower operating costs**
- **Dry suction**
- **Low system and evaporator ammonia charge**



The industrial refrigeration industry has always used the old rule of thumb: "Don't use DX Ammonia below 0°F, it won't work!". Now with patented Colmac ADX[®] technology, DX with ammonia is finally possible down to blast freezing temperatures (-50°F).

Colmac ADX[®] is available on all A+Series[™] evaporators.

Colmac has published the DX Ammonia Piping Handbook to explain how ADX[®] works and guide the reader through the process of successfully designing an ADX[®] low charge ammonia refrigeration system. See www.colmaccoil.com to download a free copy of the handbook.

ADX[®] Patents:

- US Patent No. 8,474,276
- US Patent No. 7,958,738
- US Patent No. 7,597,137
- US Patent No. 8,783,057
- US Patent No. 8,966,935
- US Patent No. 9,689,621



High Performance Glycol Coolers

Secondary refrigerants (glycols and brines) are widely used in industrial refrigeration systems as a means of (a) reducing the total ammonia charge, and (b) removing ammonia from occupied spaces (i.e. loading docks, and process rooms) and other areas highly sensitive to the risk of ammonia leaks. Unfortunately, these benefits are accompanied by a number of disadvantages including:

- ▷ Added complexity
- ▷ Increased first cost
- ▷ Increased power consumption

To minimize air cooler power consumption (added pumping power and fan power) with secondary refrigerants, Colmac A+Series™ liquid-to-air coolers have been designed with a revolutionary new tubeside enhancement system which significantly boosts cooling performance. Compared to traditional cooler designs offered by other manufacturers, A+Series™ liquid-to-air coolers with enhanced tubes have:

- ▷ 30% more cooling capacity
- ▷ Reduced pumping power
- ▷ Reduced fan power
- ▷ Reduced piping and insulation costs



Breakthrough in Hygienic Designs

Colmac specializes in hygienic coil designs for the food processing industry.



A+S cooler with:

- Stainless steel tubes and cabinet
- Anti-microbial fins
- Polypropylene full coverage drainpan

A+R cooler with:

- Stainless steel tubes and cabinet
- Epoxy coated aluminum fins
- CIP spray piping
- Full coverage insulated drainpan



Options

A+Series™ air coolers can be supplied with the following types of coil construction to match more demanding cleaning and sanitizing requirements:

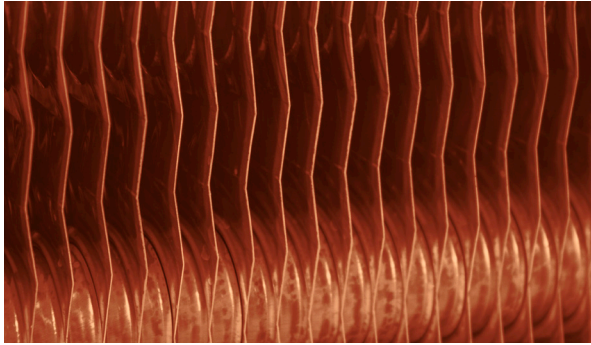

Anti-microbial Fin Alloy with Stainless Tubes

- ▷ Comparable corrosion resistance to SS tubes and fins
- ▷ Equivalent performance to SS tube and aluminum fins
- ▷ Pathogen colony counts approach zero after just 2-3 hours of exposure to fin alloy
- ▷ Not a coating that chips and peels off

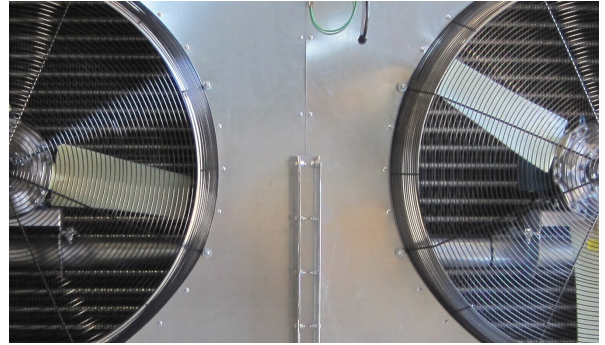

All Stainless

- ▷ Both tubes and fins can be made of type 304 or type 316 stainless steel.

Cleanability is Standard

Care has been taken to eliminate difficult to inspect and clean areas on top of the fins and between the bottom of the fins and the drainpan. Fan panels on all A+S, A+M, A+L, and A+R coolers are hinged for ease of inspection, cleaning, and service. The A+D has an optional hinged fan panel.

Cabinet sheet metal is offered in G235 galvanized steel, aluminum, or stainless steel.

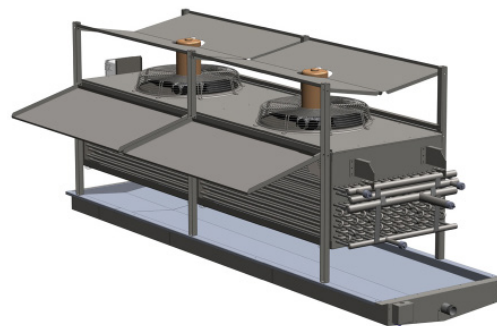
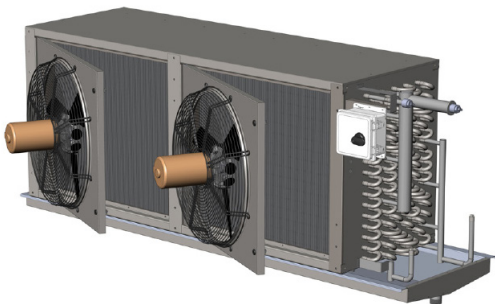

Triple-Pitch Drainpan

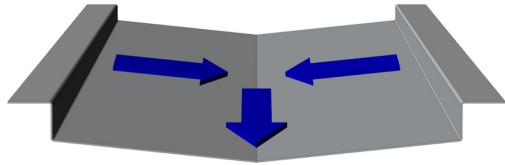

Triple Pitch



Full Radius Outlet

Colmac Coil's innovative "triple pitch" V-bottom drainpan design provides for rapid and complete drainage of melted frost and ice. The drainpan is conveniently pitched to a single drain connection on one end of the unit, simplifying drain piping. The "V" shape acts to quickly move melted frost to the center of the pan where it flows to the end of the pan and the drain. Low spots and "pooling" of melted frost in the pan are completely eliminated. Pitching the drainpan in three directions (front to center, rear to center, and end-to-end) combined with continuous hot gas loop contact has resulted in "the perfect pan".

Drain connections found in other manufacturers' drainpans are typically made of pipe nipples cut at 90 degrees and welded onto a flat hole in the drainpan sheetmetal. This type of construction distorts the drainpan and can cause incomplete drainage because of high spots around the drain outlet. Colmac Coil has solved this problem with a full radius drain outlet formed into the drainpan to eliminate the possibility of water pooling around the drain after a defrost. The Colmac A+ drainpan drains completely. No more time and money wasted de-icing drain pans.

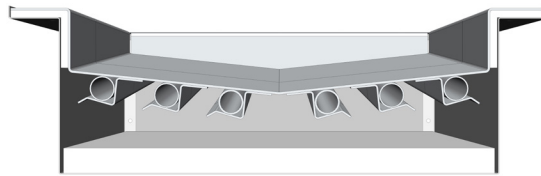

Continuous Contact Pan Loop

Other manufacturers attach the hot gas pan loop (tubes and headers) underneath the drainpan in such a way that complete contact over the length of the pan is not possible. The tubes in the drainpan loop on Colmac evaporators are held tightly in contact along the entire length of the underside of the drainpan by means of special spring tension clips. No thermal mastic paste is used or needed with the Colmac A+ design. Pan loop headers are held outside the ends of the drainpan to allow full contact of the tubes with the pan. Defrost heat is transferred to the pan surface not only by the tubes themselves, but also through the metal of the full length clips.

Drainpan Defrosting

Colmac drainpans defrost completely and quickly with maximum efficiency

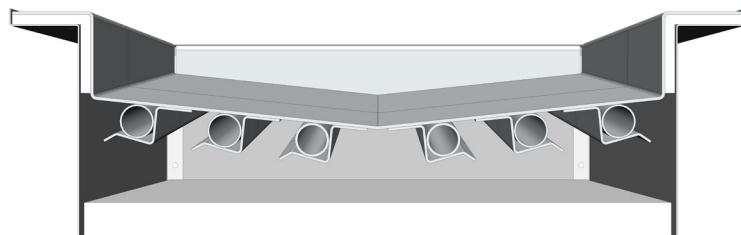

Liquid Seal Hot Gas Drainpan Loop

In conventional hot gas drainpan designs, liquid refrigerant can flood the lower tubes in the drainpan hot gas loop, rendering them much less effective in heating the pan, and resulting in slow and uneven drainpan defrosting. Colmac Coil's trapped outlet design ensures that condensed, liquid refrigerant is carried out of the pan ensuring fast, complete, and uniform heating of the pan during defrost.

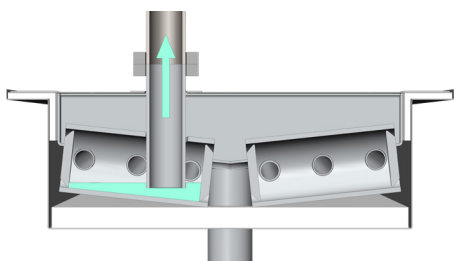

Free Draining Liquid Connections

With conventional coil designs, the liquid connection enters the liquid header in such a way that the bottom tubes in the coil stay flooded during defrost with condensed, liquid refrigerant. The result is slow, uneven (or incomplete) defrosting of the coil. Colmac Coil has solved this problem by extending the liquid header downward and placing the liquid connection below the level of the lowest tube in the coil. This design effectively traps all of the condensed liquid refrigerant and forces it out of the coil during defrost, resulting in a fast, complete and effective defrost of the entire coil.

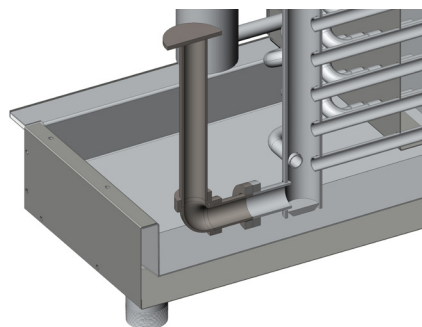

Vertical Liquid & Hot Gas Connections

Since nearly all piping in a refrigerated warehouse runs along the ceiling, and then vertically down to the evaporator coil connections, Colmac Coil's vertical liquid and hot gas connections eliminates the need for field installed elbows and piping required to connect to horizontal connections. The result is time and money saved on the jobsite during installation.

Energy Efficient Defrost

Save as much as 90% of defrosting costs with optional:

- **Return Air Defrost Hoods**
- **Discharge Duct Socks**
- **Demand Defrost Sensor**



A+M with collapsing return air hoods installed
US Patent No. 10,077,933

In freezing temperatures frost will form on the surface of air coolers which must be removed periodically by heating (defrosting). Heating the coil surfaces also unavoidably heats the surrounding air which then circulates back into the room via natural convection. This loss of defrost heat to the room can exceed 60% of the total amount of heat expended during a defrost cycle.

Typically, air coolers are defrosted at regular timed intervals for a timed duration. Since moisture infiltration into freezer spaces varies over the course of the year, the corresponding frost load on coils varies as well. When defrosts are initiated and terminated on a timed basis, the possibility exists to defrost too often and too long when frost loads are light (during winter months in cold climates). An ideal highly efficient approach to defrosting air coolers would a) capture the heat being lost to the room via convection of heated air, b) defrost only when needed and for as long as required to clear the coil of frost. By accomplishing both (a) and (b) as much as 85% of the energy expended to defrost air coolers can be eliminated.

A+Series™ air coolers can be supplied with optional return air defrost hoods and discharge duct socks to effectively capture defrost heat within the unit cabinet. In addition, the optional Demand Defrost Sensor can be factory mounted on A+Series™ coolers to work in conjunction with the building SCADA / BMS computer system to initiate and terminate defrosts based on sensed frost load on individual coolers.

It has been shown that the cost of a single 30-minute hot gas defrost cycle ranges from \$0.15 to \$0.20 per defrost per TR. Assuming 3 timed defrosts per day, the cost to defrost air coolers having combined capacity of 500 TR would be \$109,500 per year. Assuming the addition of return air defrost hoods and discharge duct socks captures the 60% defrost normally lost and that the Demand Defrost Sensor reduces the defrost duration by half and reduces the number of defrosts by half, the calculated cost of defrosting the same air coolers becomes only \$10,950 per year – a savings of 90% or \$98,550 per year.

Return Air Defrost Hood

The Colmac Return Air Defrost Hood is a fully insulated series of hinged panels which collapse for shipment and then open quickly and easily into the operating position. The sturdy panels are made of insulated double-wall construction with active heating to prevent condensation and frosting on the interior surfaces of the hood during defrost. Colmac Return Air Defrost Hoods can be added as an option to any A+Series™ air cooler.

- ▷ Faster and more complete defrosts
- ▷ Reduced frost and ice on ceilings and walls
- ▷ Reduced power consumption

A thermal finite element analysis was performed on two evaporators mounted in a single penthouse arranged for sequential defrosting, to visualize the effect of adding Colmac Return Air Defrost Hoods on heat loss during defrost. The result is a dramatic reduction in heat lost by the defrosting unit and an increase in the cooling performance of the operating unit.

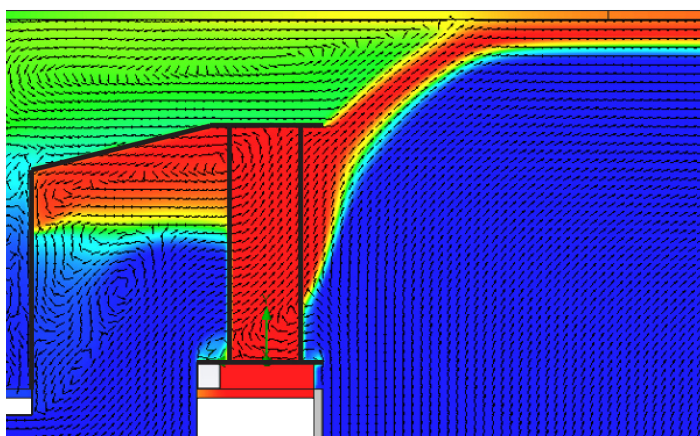

A+L Penthouse Without Hoods

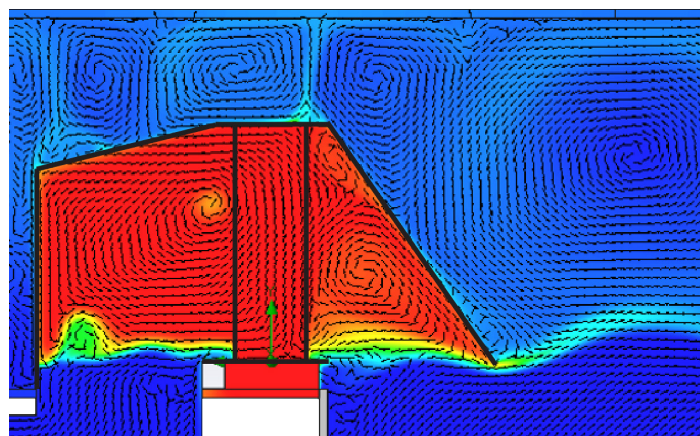

A+L Penthouse With Hoods

Discharge Duct Sock

- ▷ Lightweight cleanable polyester duct fabric
- ▷ Inflates during fan operation
- ▷ Collapses to capture heat during defrost
- ▷ Passive operation requires minimum fan power for inflation

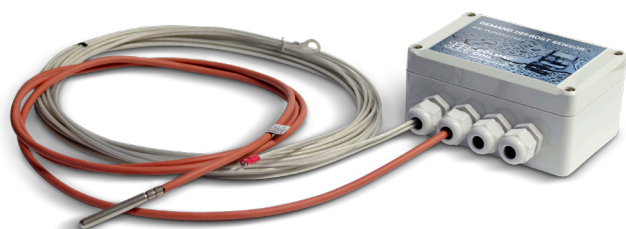

Demand Defrost Sensor

- ▷ As frost builds, the sensor's capacitance changes, allowing its control signal output to vary with the frost thickness.
- ▷ Simple, robust, and reliable
- ▷ Factory mounted
- ▷ Low cost

Water Defrost

- Washes/cleans fin surface
- Fast defrost
- Energy efficient
- Simple

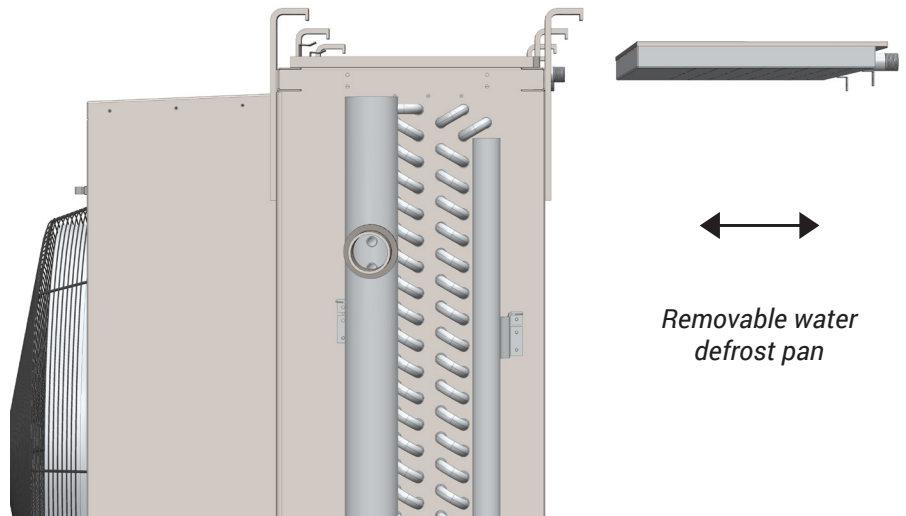

Features

Thermodynamically correct water flow rate

- ▷ Traditionally, the amount of defrost water shown by evaporator manufacturers has been based on rules of thumb such as "1-1/2 to 2 gpm per sq foot of face area", or "3 gpm per sq foot of top area". These rules of thumb are overly conservative and result in higher-than-needed defrost water flow rates and pumping power. Colmac limits the defrost water flow rate to only the amount needed to heat the mass of the coil metal and melt the frost, no more.

Removable, cleanable water distribution pans

- ▷ Fouling and plugging of spray nozzles is mitigated by the use of removable, cleanable water distribution pans. The distribution pans are designed to be easily removable for inspection and cleaning while the evaporator remains in place, undisturbed.

Patented Electric Defrost

This patented electric defrost heater element design eliminates elements “creeping” or “walking” out of the heat exchanger, which can cause damage to elements and wiring. The proprietary design extends heater element life and reduces the risk of damage and electrical failures.

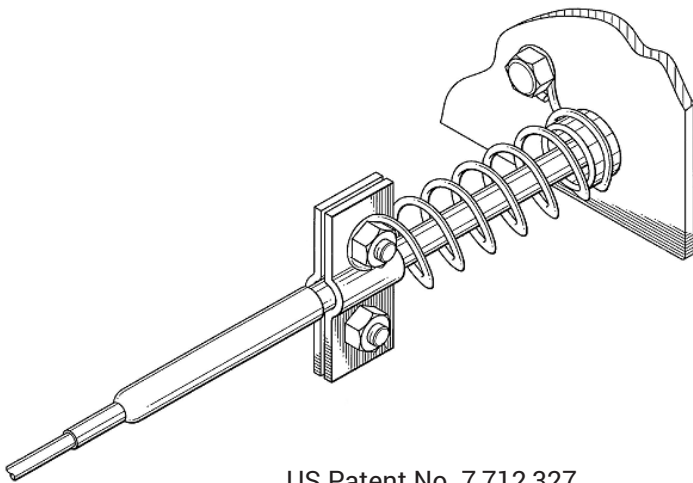

US Patent No. 7,712,327



Other Options

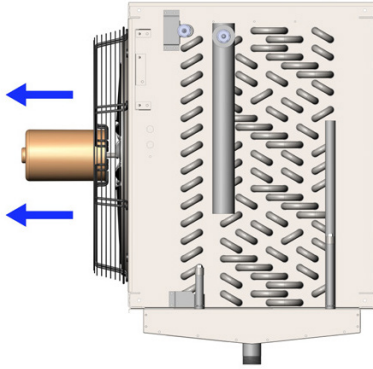

Re-heat Coil

Re-heats air leaving the evaporator coil to control room humidity

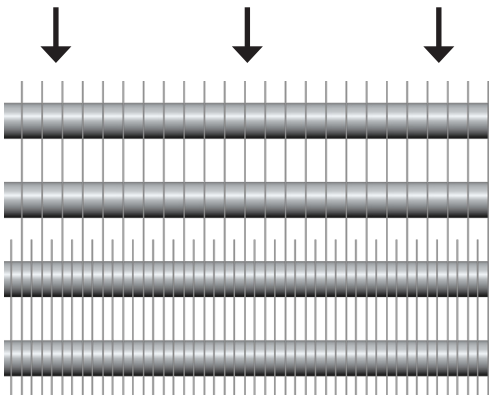

Variable Fin Spacing

For severe frost applications, fins on the air inlet face of the coil have wider fin spacing than the remainder of the coil. The wider spacing allows for more frost build-up before defrosting becomes necessary, resulting in fewer defrosts compared to a coil without variable fin spacing.

Drainpan Electric Heat Trace

Use this option for conditions where the room temperature is above freezing and the drainpan cover temperature may drop below the dew point temperature of the room air, resulting in condensate forming on the cover and dripping. The heat trace keeps the drain pan cover above the room dew point temperature, and eliminates the possibility of condensation.

Extended Legs

For applications where a floor mounted coil must be elevated

Alternate Voltages and 50Hz motors

Units can be designed and manufactured to be compatible with power supplies anywhere in the world.

A+ Pro Selection Software

Colmac offers qualified users access to its powerful online applications software. The Refrigeration Load Simulator application accurately models and predicts the refrigeration load for an entire facility. This first-of-its-kind program calculates sensible and latent cooling loads, moisture removal rates, room rh%, fan power, defrost frequency, and other useful operating parameters. Output is saved and transferred directly to A+Pro air cooler selection software for accurate selection, specification, and pricing of A+Series™ air coolers.

Units of Measure	Rating Criteria	Method	Model
IP SI	DTI DTM	Select Rate	A+S A+M A+L A+R A+B A+D

System Configuration			
Unit Type	Reheat?	Reheat Rows	
Refrigerant Evaporator	Yes No	2	
Refrigerant	Defrost, Coil	Defrost, Pan	Hot Gas Piping
Ammonia	Hot Gas	Hot Gas	3 Pipe (Series)
System Type	Overfeed Ratio		
Recirc. Bottom	5 to 1		
Air Flow Configuration			
Flow Orientation	Fan Discharge	Air Inlet	External Static
Draw Through	Standard	Standard	0in H ₂ O



Model#	Relative Price	Gross Capacity (TR)	Capacity Variation (%)	ΔT
A+L23T-24-112-83.0C-0300L-ARB-GG-SD	0.000	14.2	110.35	
A+L23T-26-129-63.0C-0300L-ARB-GG-SD	2.318	14.6	113.15	
A+L23T-28-120-63.0C-0300L-ARB-GG-SD	2.419	14.1	109.66	
A+L23T-22-122-83.0C-0300L-ARB-GG-SD	2.448	14.0	108.72	
A+L33T-24-140-63.0C-0150L-ARB-GG-SD	6.412	13.1	101.5	
A+L33T-22-153-63.0C-0150L-ARB-GG-SD	6.652	13.7	106.7	
A+L33T-20-134-83.0C-0150L-ARB-GG-SD	10.252	12.5	97.0	
A+L23T-34-140-43.0C-0500L-ARB-GG-SD	10.286	13.6	105.7	
A+L33T-24-199-43.0C-0300L-ARB-GG-SD	13.587	13.2	102.9	
A+L33T-20-168-63.0C-0300L-ARB-GG-SD	14.397	14.0	108.8	
A+L33T-26-183-43.0C-0200L-ARB-GG-SD	14.537	15.0	116.41	
A+L33T-28-170-43.0C-0200L-ARB-GG-SD	14.813	15.1	117.03	
A+L43T-24-199-43.0C-0150L-ARB-GG-SD	18.39	12.9	100.18	

Showing 1 to 18 of 18 entries



Uncrating & Rigging

A+Series™ evaporators are crated and designed for fast and safe installation



Cradle Crating System

The unique cradle crating system from Colmac is made of heavy duty dimensional lumber to support the full weight of the evaporator while withstanding the rigors of shipment. The cradle crate safely supports the weight of the evaporator while it is lifted into position from below. Then after the evaporator is secured to the ceiling, the crate easily comes away from the unit by gravity allowing it to be safely lowered to the ground.

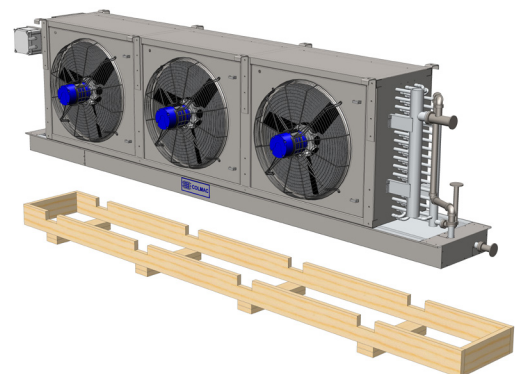
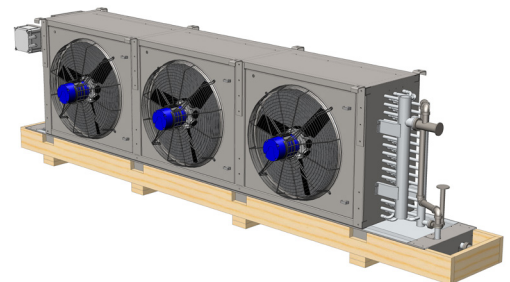

Smart Hanger System

This optional patented design was developed to make the process of mounting ceiling-hung evaporators faster and safer. Smart hanger brackets and rails allow evaporator units to be hung from the ceiling without any personnel leaving the floor level. The time consuming process of aligning threaded rods into mounting holes while the unit is being lifted into position is eliminated, reducing suspended load time by as much as 75%. Side to side placement of the evaporator on the Smart Hanger rails is non-critical and therefore faster.

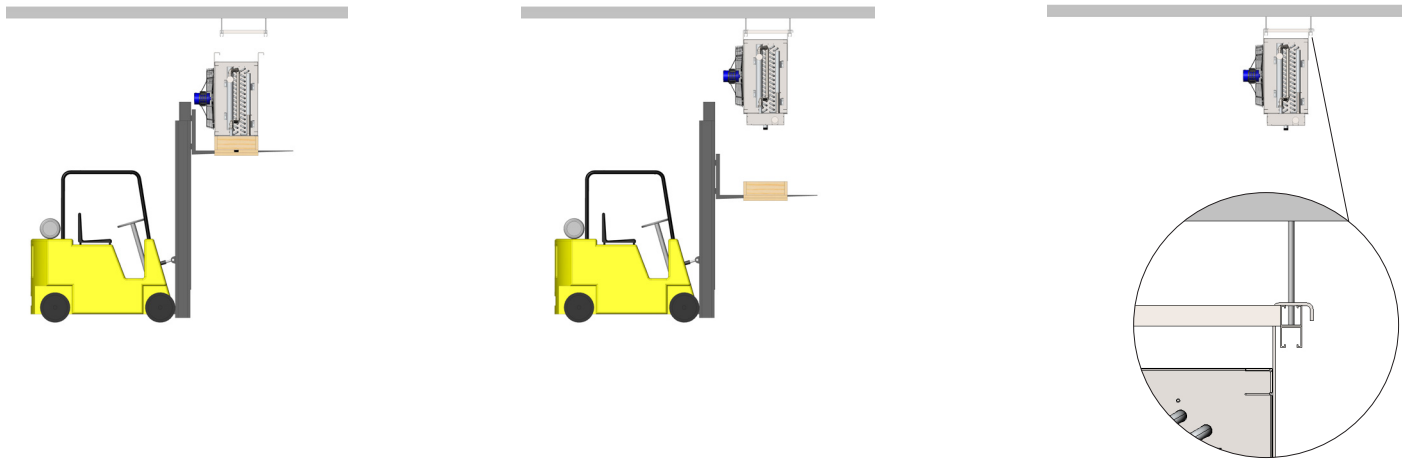

US Patent No. 6,457,692



Shrink Wrap Packaging

Shrink wrap packaging is a plastic material that is wrapped around products for shipping or storage. After applying heat to the plastic, a tight seal is formed to the exact shape of the product. With a life of 1 - 2 years, products can be stored safely for a significant amount of time before installation.



Quality Products From Colmac Coil



Heating and Cooling Coils



Heat Pipes for Heat Recovery



A+Series™ Air Coolers



Air Cooled Condensers

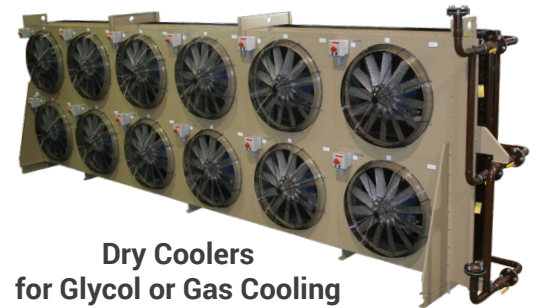

Dry Coolers
for Glycol or Gas Cooling

www.colmaccoil.com

"The Heat Transfer Experts"

North American Headquarters

Colmac Coil Manufacturing, Inc.
370 N. Lincoln St. | P.O. Box 571
Colville, WA 99114 | USA
+1.509.684.2595 | +1.800.845.6778

Midwest US Manufacturing

Colmac Coil Midwest
350 Baltimore Dr. | Paxton, IL 60957 | USA



CRN



CSA

ASME Sec. VIII, Canadian Registration Number, UL508, Canadian Standards Association